



Room thermostats with KNX communications

RDG100KN
RDG160KN
RDG165KN

- For fan coil unit applications
- For universal applications
- For use with compressor in DX type equipment

-
- **KNX bus communication (S-mode and LTE mode)**
 - **Backlit display**
 - **2P/PI/P control**
 - **Outputs for On/Off, PWM, 3-position or DC 0...10 V control**
 - **Outputs for 3-speed, 1-speed, or DC (DC 0...10 V) fan**
 - **3 multifunctional inputs for keycard contact, external sensor, etc.**
 - **Operating modes: Comfort, Economy and Protection**
 - **Automatic or manual fan speed control**
 - **Automatic or manual heating/cooling changeover**
 - **Minimum and maximum limitation of room temperature setpoint**
 - **Control depending on the room or the return air temperature**
 - **Selectable relay output functions (RDG16..KN)**
 - **Built-in humidity sensor and humidity control (RDG165KN)**
 - **Adjustable commissioning and control parameters**
 - **Commissioning with Synco ACS, ETS or via local HMI**
 - **Integration into Synco**
 - **Integration into Desigo via group addressing (ETS) or via individual addressing**
 - **Integration into third-party system via group addressing (ETS)**
 - **Operating voltage:**
RDG100KN: AC 230 V
RDG16..KN: AC 24 V

Edition 5.0

CE1N3191en
2016-09-21

The RDG1.. KNX room thermostats are designed for use with the following types of system:

Fan coil units via On/Off or modulating/DC control outputs:

- 2-pipe system
- 2-pipe system with electric heater
- 2-pipe system and radiator/floor heating
- 4-pipe system
- 4-pipe system with electric heater (RDG100KN)
- 2-stage heating or cooling system

Chilled/heated ceilings (or radiators) via On/Off or modulating/DC control outputs:

- Chilled/heated ceiling
- Chilled/heated ceiling with electric heater
- Chilled/heated ceiling and radiator/floor heating
- Chilled ceiling and radiator/floor heating
- Chilled/heated ceiling, 2-stage cooling or heating
- Chilled/heated ceiling with 6-port ball valve (RDG160KN version \geq V1.14)
- Chilled/heated ceiling with PICV valve and a 6-port ball valve as changeover (RDG160KN version \geq V1.14)

Compressor applications via On/Off control (RDG16..KN):

- Heating or cooling, compressors in DX-type equipment
- Heating or cooling, compressors in DX-type equipment with electric heater
- Heating or cooling, compressors in DX-type equipment
- 2-stage heating or cooling, compressors in DX-type equipment

The RDG100KN controls...

- One 1-speed or 3-speed fan
- One or two On/Off, PWM, or 3-position valve actuators
- One valve actuator and one electric heater/radiator

The RDG16..KN controls...

- One 1-speed, 3-speed or DC 0...10 V fan
- One or two On/Off valve actuators, electric heater, or radiator with DC fan
- One or two DC valve actuators, electric heater, or radiator with DC fan
- One or two DC valve actuators, electric heater, or radiator with 1-speed or 3-speed fan
- One On/Off valve actuator, one DC valve actuator with DC fan
- 1-stage or 2-stage compressor in DX-type equipment, with electric heater/radiator

Used in systems with:

- Heating or cooling mode
- Automatic heating/cooling changeover
- Manual heating/cooling changeover
- Heating and cooling mode (e.g. 4-pipe system)

The room thermostats are delivered with a fixed set of applications.

The relevant application is selected and activated during commissioning using one of the following tools:

- Synco ACS
- ETS
- Local DIP switch and HMI

- Room temperature control via built-in temperature sensor or external room temperature/return air temperature sensor
- Minimum/maximum humidity control by shifting temperature setpoint and releasing contact for dehumidifier/humidifier (RDG165KN)
- Changeover between heating and cooling mode (automatic via local sensor or bus, or manually)
- Selection of applications via DIP switches or commissioning tool (ACS, ETS)
- Parameters download with commissioning tool (ACS, ETS)
- Selection of operating modes via operating mode button
- Temporary Comfort mode extension
- 1-speed, 3-speed or DC 0...10 V fan control (automatically or manually)
- Display of current room temperature or setpoint in °C or °F
- Minimum and maximum limitation of room temperature setpoint
- Button lock (automatically or manually)
- 3 multifunctional inputs, selectable for:
 - Operating mode switchover contact (keycard, window contact, etc.)
 - Window contact switches operating mode to Protection (RDG16..KN)
 - Presence detector switches operating mode to Comfort (RDG16..KN)
 - Sensor for automatic heating/cooling changeover
 - External room temperature or return air temperature sensor
 - Dewpoint sensor
 - Electric heater enable
 - Fault input
 - Monitor input for temperature sensor or switch status
 - Supply air temperature sensor (RDG16..KN)
- Advanced fan control function, e.g. fan kick, fan start delay, selectable fan operation (enable, disable or depending on heating/cooling mode)
- Purge function together with 2-port valve
- Reminder to clean fan filters (P62)
- Floor heating temperature limitation
- Minimum and maximum supply air temperature limitation (RDG16..KN)
- Interworking with AQR and QMX sensor for room humidity and room temperature measurement (RDG165KN)
- Interworking with QMX room operator units for room humidity, room temperature and operating commands for fan, operating mode and setpoints (RDG165KN)
- Swap function for 2-pipe and 2-stage application by switching the 1st stage heating to the 2nd stage cooling (RDG165KN)
- Enabling fan output only in the 2nd stage (RDG165KN)
- Control 6-port ball valve for chilled and heated ceiling, DC 0...10 V or DC 2...10 V (RDG160KN)
- Combination with auto-balanced valve DC 0...10 V (PICV) and 6-port ball valve as changeover (on/off – open/close) for chilled and heated ceiling (RDG160KN)
- Control of 6-port ball valve via KNX S-mode objects (RDG160KN)
- Selectable relay functions (RDG16..KN):
 - Switching off external equipment during Protection mode
 - Switching on external equipment (e.g. pump) during heating/cooling mode
 - Output status heating/cooling sequence
 - Dehumidification/humidification control output (RDG165KN)
- Reload factory settings for commissioning and control parameters
- KNX bus (terminals CE+ and CE-) for communication with Synco or KNX compatible devices
- Display of outside temperature or time of day via KNX bus
- Time scheduling and central control of setpoints via KNX bus
- Control of Economy setpoints via KNX bus (RDG16..KN)
- Energy supply optimization via energy demand signal with a Synco RMB795B central control unit

Applications

The RDG1..KN room thermostats support the following applications, which can be configured using the DIP switches at the rear of the unit or a commissioning tool.

Remote configuration

Set DIP switches 1...3 to OFF (remote configuration, factory setting) to select an application via commissioning tool.

Remote configuration, via commissioning tool (factory setting) <ul style="list-style-type: none">• Synco ACS• ETS	 <p>DIP switches</p> <p>ON</p> <p>OFF</p> <p>1 2 3 4 5</p>
--	---

Notes

RDG100KN

- Use P46/P47 to change the control output from On/Off (factory setting) to PWM
- Use DIP switches 4 and 5 to change the control output from On/Off to 3-position

RDG16..KN

- Use P46/P47 to change the valve actuator output from DC (factory setting) to On/Off
- Use DIP switch 4 to change the fan output from DC (factory setting) to 3-speed

Applications for fan coil systems

Applications, DIP setting, control outputs

<ul style="list-style-type: none"> 2-pipe fan coil unit <p>Using RDG100KN, RDG16..KN</p>	<ul style="list-style-type: none"> 2-pipe fan coil unit and electric heater <p>Using RDG100KN, RDG16..KN</p>	<ul style="list-style-type: none"> 2-pipe fan coil unit and radiator/floor heating <p>Using RDG100KN, RDG16..KN</p>
<ul style="list-style-type: none"> 2-pipe/2-stage fan coil unit <p>Using RDG100KN, RDG16..KN</p>	<ul style="list-style-type: none"> 4-pipe fan coil unit <p>Using RDG100KN, RDG16..KN</p>	<ul style="list-style-type: none"> 4-pipe fan coil unit and electric heater <p>Using RDG100KN</p>

- | | |
|--------------------------------------|---|
| YHC.. Heating/cooling valve actuator | M1 1-speed or 3-speed fan |
| YH Heating valve actuator | B1 Return air temperature sensor or external room temperature sensor (optional) |
| YC Cooling valve actuator | B2 Changeover sensor (optional) |
| YE Electric heater | |

Product no.	Control outputs	Fan
RDG100KN	On/Off, PWM, 3-position	3-speed, 1-speed
RDG16..KN	DC 0...10 V	3-speed, 1-speed, DC 0...10 V
	On/Off	DC 0...10 V

Applications for Universal systems

Applications, DIP setting, control outputs								
<ul style="list-style-type: none"> Chilled/heated ceiling <p>Using RDG100KN, RDG16..KN</p>	<ul style="list-style-type: none"> Chilled/heated ceiling and electric heater <p>Using RDG100KN, RDG16..KN</p>	<ul style="list-style-type: none"> Chilled/heated ceiling and radiator/floor heating <p>Using RDG100KN, RDG16..KN</p>						
<ul style="list-style-type: none"> 2-stage chilled/heated ceiling <p>Using RDG100KN, RDG16..KN</p>	<ul style="list-style-type: none"> Chilled ceiling and radiator <p>Using RDG100KN, RDG16..KN</p>	<ul style="list-style-type: none"> Chilled and heated ceiling control with 6-port ball valve <p>Using RDG160KN (version ≥ V1.14)</p>						
<ul style="list-style-type: none"> Chilled and heated ceiling control with PICV and 6-port ball valve as change over <p>Using RDG160KN (version ≥ V1.14)</p>	<p>YHC.. Heating/cooling valve actuator YH Heating valve actuator YC Cooling valve actuator YE Electric heater D3 Dewpoint sensor M1 1-speed or 3-speed fan B1 Return air temperature sensor or external room temperature sensor (optional) B2 Changeover sensor (optional)</p> <table border="1"> <thead> <tr> <th>Product no.</th> <th>Control outputs</th> </tr> </thead> <tbody> <tr> <td>RDG100KN</td> <td>On/Off, PWM, 3-position</td> </tr> <tr> <td>RDG16..KN</td> <td>On/Off, DC 0...10 V</td> </tr> </tbody> </table>		Product no.	Control outputs	RDG100KN	On/Off, PWM, 3-position	RDG16..KN	On/Off, DC 0...10 V
Product no.	Control outputs							
RDG100KN	On/Off, PWM, 3-position							
RDG16..KN	On/Off, DC 0...10 V							

Applications for heat pump systems (RDG16..KN)

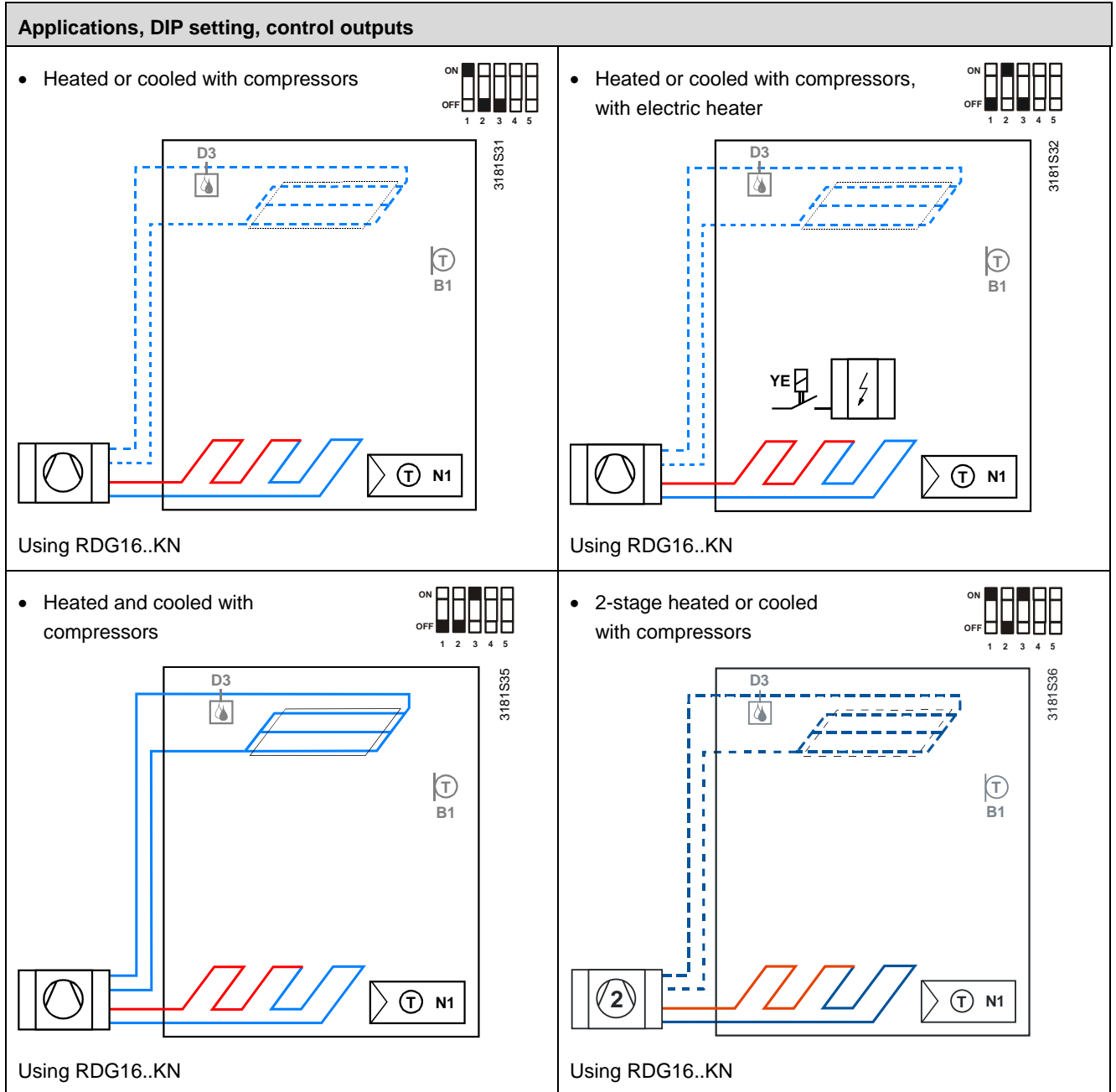

N1 Thermostat
 Output Y10/Q1: Heating or heating/cooling
 Output Y20/Q2: Cooling only (heating/cooling)
 YE Electric heater

B1 Return air temperature sensor or external room temperature sensor (optional)
 D3 Dewpoint sensor

Product no.	Control outputs	Fan
RDG16..KN	On/Off, DC 0...10 V	Disabled, DC 0...10 V

Type summary

Product no.	Stock no.	Features								
		Operating voltage	Number of control outputs				Fan		Humidity	Backlit LCD
			On/Off	PWM	3-pos.	DC	3-speed	DC		
RDG100KN	S55770-T163	AC 230 V	3 ¹⁾	2 ¹⁾	2 ¹⁾			✓		✓
RDG160KN	S55770-T297	AC 24 V	2 ²⁾			2 ²⁾		✓		✓
						2	✓ ³⁾			
RDG165KN	S55770-T347	AC 24 V	2 ²⁾			2 ²⁾		✓	✓	✓
						2	✓ ³⁾	✓ ⁴⁾		













¹⁾ Selectable: On/Off, PWM or 3-position (triac outputs)

²⁾ On/Off or DC control signal

















³⁾ 3-speed fan selectable only via DC control outputs

⁴⁾ Release contact dehumidifier via external DC – On/Off converter

Equipment combinations

	Description		Product no.	Data Sheet*)
	Cable temperature or changeover sensor, cable length 2.5 m NTC (3 kΩ at 25 °C)		QAH11.1	1840
	Room temperature sensor NTC (3 kΩ at 25 °C)		QAA32	1747
	Condensation monitor		QXA21..	A6V10741072
	Flush-mount KNX room sensor (Base and front module)		AQR2570N.. AQR2532NNW AQR2533NNW AQR2535NNW	1411
	Wall-mounted KNX sensors		QMX3.P30 QMX3.P70	1602
On/Off actuators	Electromotoric On/Off actuator		SFA21..	4863
	Electromotoric On/Off valve and actuator (only available in AP, UAE, SA and IN)		MVI../MXI..	4867
	Zone valve actuator (only available in AP, UAE, SA and IN)		SUA..	4832
On/Off and PWM actuators ¹⁾	Thermal actuator (for radiator valves) AC 230 V, NO		STA23.. ¹⁾	4884
	Thermal actuator (for radiator valves) AC 24 V, NO		STA73.. ¹⁾	4884
	Thermal actuator AC 230 V (for small valves 2.5 mm), NC		STP23.. ¹⁾	4884
	Thermal actuator AC 24 V (for small valves 2.5 mm), NC		STP73.. ¹⁾	4884

3-position actuators

Electrical actuator, 3-position (for radiator valves)		SSA31..	4893
Electrical actuator, 3-position (for 2- and 3-port valves/V..P45)		SSC31	4895
Electrical actuator, 3-position (for small valves 2.5 mm)		SSP31..	4864
Electrical actuator, 3-position (for small valves 5.5 mm)		SSB31..	4891
Electrical actuator, 3-position (for small valve 5 mm)		SSD31..	4861
Electromotoric actuator, 3-position (for valves 5.5 mm)		SAS31..	4581
Rotary actuators for ball valves 3-position		GDB331.9E	4657
DC 0...10 V actuators			
Electrical actuator, DC 0...10 V (for radiator valves)		SSA61..	4893
Electrical actuator, DC 0...10 V (for 2- and 3-port valves/V..P45)		SSC61..	4895
Electrical actuator, DC 0...10 V (for small valves 2.5 mm)		SSP61..	4864
Electrical actuator, DC 0...10 V (for small valves 5.5 mm)		SSB61..	4891
Electromotoric actuator, DC 0...10 V (for valves 5.5 mm)		SAS61..	4581
Electrothermal actuator, AC 24 V, NC, DC 0...10 V, 1 m		STA63	4884
Electrothermal actuator, AC 24 V, NO, DC 0...10 V, 1 m		STP63	4884
Rotary actuators for ball valves AC 24 V, DC 0...10 V		GDB161.9E	4657
Rotary actuators for ball valves KNX S-Mode		GDB111.9E/KN	A6V1072 5318

*) The documents can be downloaded from <http://siemens.com/bt/download>.

¹⁾ With PWM control, it is not possible to ensure exact parallel running of 2 or more thermal actuators. If several fan-coil systems are controlled by the same room thermostat, preference should be given to motorized actuators with On/Off or 3-position control.

Note For more information about parallel operation and the maximum number of actuators that can be used, refer to the Data Sheets of the selected type of actuator and the following list:

Maximum number of actuators in parallel on the RDG100KN:

- 6 SS..31.. actuators (3-position)
- 4 ST..23.. if used with On/Off control signal
- 10 SFA., SUA., MVI., MXI.. On/Off actuators
- Parallel operation of SAS31 is not available
- GDB331.9E

Maximum number of actuators in parallel on the RDG16..KN:

- 10 SS..61.. actuators (DC)
- 10 ST..23/63/73.. actuators (DC or On/Off)
- 10 SFA., SUA., MVI., MXI.. On/Off actuators
- 10 SAS61.. actuators (DC)
- 10 GDB161.9E

Accessories

Description	Product/stock no.	Data Sheet
KNX power supply 160 mA (Siemens BT LV)	5WG1 125-1AB02	--
KNX power supply 320 mA (Siemens BT LV)	5WG1 125-1AB12	--
KNX power supply 640 mA (Siemens BT LV)	5WG1 125-1AB22	--

Mechanical design

The room thermostat consists of two parts:

- Plastic housing with electronics, operating elements and room temperature sensor
- Mounting plate with the screw terminals

The housing engages in the mounting plate and is secured with 2 screws.

Operation and settings

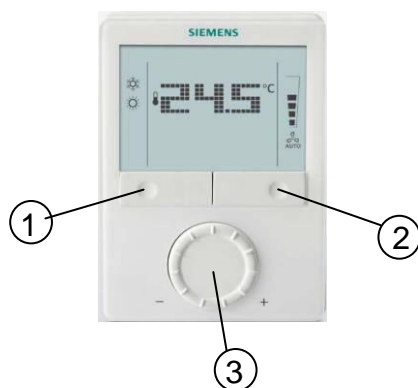

- 1) Operating mode button/Esc
- 2) Fan mode button/Ok
- 3) Rotary knob to adjust setpoints and parameters

Display

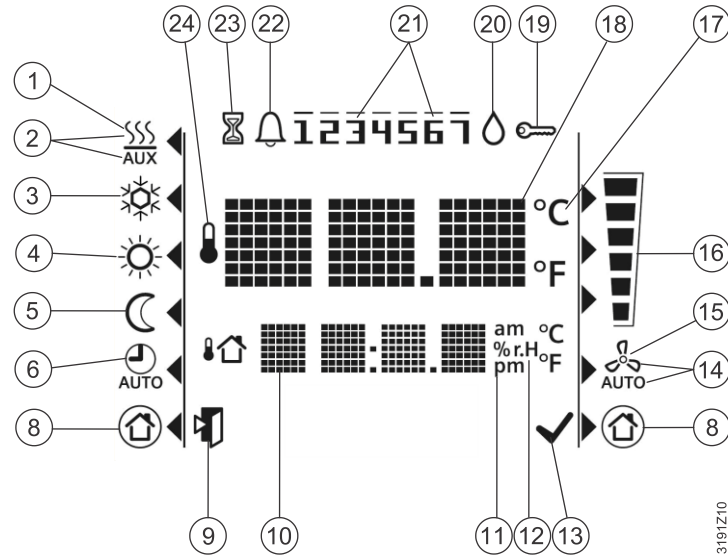

3191Z10

#	Symbol	Description	#	Symbol	Description
1		Heating mode	15		Manual fan
2		Heating mode, electric heater active	16		Fan speed I
3		Cooling mode			Fan speed II
4		Comfort mode			Fan speed III
5		Economy mode	17		Degrees Celsius Degrees Fahrenheit
6		Auto mode according to schedule (via bus)	18		Digits for room temperature and setpoint display
8		Protection mode	19		Button lock
9		Escape	20		Condensation in room (dewpoint sensor active) or humidity control active
10		Additional user information, such as outside temperature, or time of day from KNX bus, or relative humidity (RDG165KN only) Selectable via parameters	21		Weekday 1...7 from KNX bus 1 = Monday/7 = Sunday
11		Morning: 12-hour format Afternoon: 12-hour format	22		Fault
12	%r.H symbol"/>	Relative humidity (RDG165KN only)	23		"Temporary timer" function; displays when operating mode is temporarily extended (extended presence or absence)
13		Confirmation of parameters	24		Indicates that room temperature is displayed
14		Automatic fan			

See the "Reference documentation" on page 18 for information on how to engineer the KNX bus (topology, bus repeaters, etc.) and how to select and dimension connecting cables for supply voltage and field devices.

Mounting and installation

Do not mount on a wall in niches or bookshelves, behind curtains, above or near heat sources, or exposed to direct solar radiation. Mount it about 1.5 m above the floor.

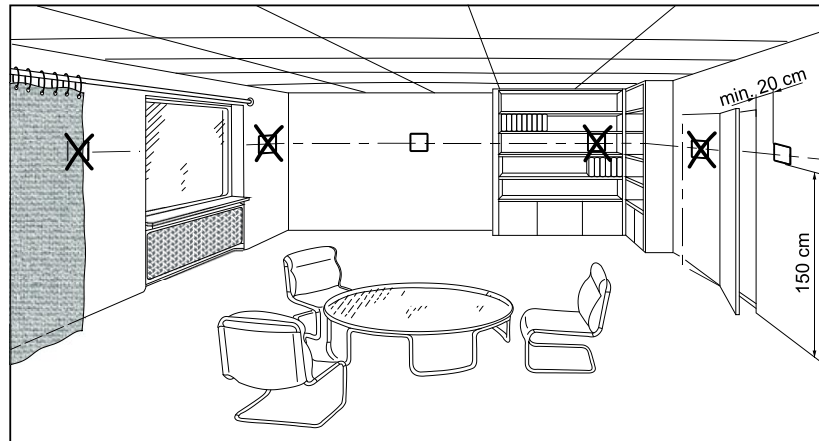

Mounting



- Mount the room thermostat on a clean, dry indoor place without direct airflow from a heating/cooling device, and not exposed to drips or splash water. See Mounting Instructions M3191, M3191.1 or M3191.2 enclosed with the thermostat.

Wiring



- Comply with local regulations to wire, protect and earth the thermostat.

Warning!

No internal line protection for supply lines to external consumers (Q1, Q2, Q3, Yx or Yxx)!

Risk of fire and injury due to short-circuits!



- Adapt the line diameters as per local regulations to the rated value of the installed overcurrent protection device
- The AC 230 V mains supply line must have an external circuit breaker with a rated current of no more than 10 A
- Properly size the cables to the thermostat, fan and valve actuators for AC 230 V mains voltage
- Use only valve actuators rated for AC 230 V
- Inputs X1-M, X2-M or D1-GND: several switches (e.g. summer/winter switch) may be connected in parallel. Consider overall maximum contact sensing current for switch rating
- Inputs X1-M and X2-M carry mains potential (RDG100KN only). Sensor cables must be suited for AC 230 V mains voltage
- Selectable relay function (RDG16..KN): Follow instructions in Basic Documentation P3191 to connect external equipment to the relay outputs



- Isolate the cables of input D1-GND and KNX communication input CE+/CE- for AC 230 V if the conduit box carries AC 230 V mains voltage
- Disconnect from power supply before removing from the mounting plate
- If a KNX bus power supply is connected to the line with communicating thermostats and Synco controller, the internal KNX power supply of the Synco controllers must be switched off

Commissioning notes

Applications

The room thermostats are delivered with a fixed set of applications.

Select and activate the relevant application during commissioning using one of the following tools:

- Local DIP switches and HMI
- Synco ACS
 - Version 5.11 or higher (for RDG1..0KN)
 - Version 8.32 or higher (for RDG165KN)
- ETS4 or higher versions

DIP switches

Set the DIP switches before snapping the thermostat to the mounting plate, if you want to select an application via DIP switches.

Set all DIP switches to OFF (remote configuration) if you want to select an application via commissioning tool.

After power is applied, the thermostat resets and all LCD segments flash, indicating that the reset was correct. After the reset, which takes about 3 seconds, the thermostat is ready for commissioning by qualified HVAC staff.

If all DIP switches are OFF, **NO APPL** displays, indicating that application commissioning via a tool is required.

Note Each time the application is changed, the thermostat reloads the factory setting for all control parameters, except for KNX device and zone addresses!

Connect tools

Connect the Synco ACS or ETS tools to the KNX bus cable at any point for commissioning:

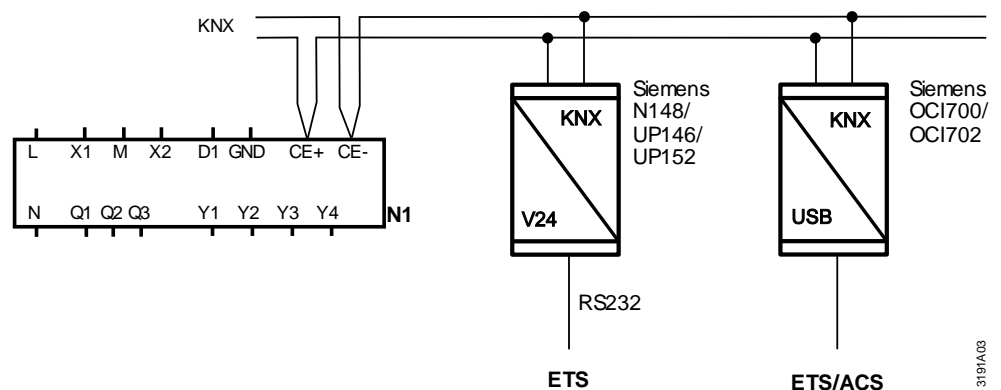

ACS and ETS require an interface:

- RS232 KNX interface (e.g. Siemens N148/UP146/UP152)
- OC1700, OC1702 USB- KNX interface

Note An external KNX bus power supply is required if an RDG1..KN is connected directly to a tool (ACS or ETS) via KNX interface.

Control parameters

The thermostat's control parameters can be set to ensure optimum performance of the entire system (see basic documentation P3191).

The parameters can be adjusted using

- Local HMI
- Synco ACS
- ETS

Control sequence

- Set the control sequence via parameter P01 depending on the application. The factory setting is as follows:

Application	Factory setting P01
2-pipe and chilled/heated ceiling, and 2-stage	1 = cooling only
4-pipe, chilled ceiling and radiator	4 = heating and cooling

Calibrate sensor

- Recalibrate the temperature sensor if the room temperature displayed on the thermostat does not match the room temperature measured (after min. 1 hour of operation). To do this, change parameter P05.

Setpoint and range limitation

- We recommend to review the setpoints and setpoint ranges (P08...P12) and change them as needed to achieve maximum comfort and save energy.

Programming mode

The programming mode helps identify the thermostat in the KNX network during commissioning.

Press both the left and right buttons simultaneously for 6 seconds to activate programming mode, which is indicated on the display with **PrO9**.

Programming mode remains active until thermostat identification is complete.

Assign KNX device address

Assign device address (P81) via HMI, ACS or ETS.

Set the device address to 255, and then the communication is deactivated (no exchange of process data).

Assign KNX group addresses

Use ETS to assign the KNX group addresses of the thermostat's communication objects.

KNX serial number

Each device has a unique KNX serial number at the rear.

An additional sticker with the same KNX serial number is enclosed in the packaging box. This sticker is intended for installers for documentation purposes.

Disposal



The devices are considered electronics devices for disposal in terms of European Directive 2012/19/EU and may not be disposed of as domestic waste.

- Dispose of the device via the channels provided for this purpose.
- Comply with all local and currently applicable laws and regulations.

Technical data

RDG100KN

 Power supply

Rated voltage	AC 230 V
Frequency	50/60 Hz
Power consumption	Max. 8 VA/1 W



No internal fuse!

External preliminary protection with max. C 10 A circuit breaker required in all cases.

Outputs

Fan control Q1, Q2, Q3 – N	AC 230 V
Rating min, max resistive (inductive)	5 mA...5(4) A



No internal fuse!

External preliminary protection with max. C 10 A circuit breaker in the supply line required under all circumstances

 Note!

Do NOT connect fans in parallel!

Connect one fan directly, for additional fans, one relay for each speed.

Control outputs	Solid state (triacs)
Y1, Y2, Y3, Y4-N	AC 230 V, 8 mA...1 A
Power limitation	3 A fast microfuse, cannot be exchanged

Inputs

Multifunctional inputs

X1-M/X2-M

Temperature sensor input

Type	QAH11.1 (NTC)
Temperature range	0...49 °C
Cable length	Max. 80 m

Digital input

Operating action	Selectable (NO/NC)
Contact sensing	DC 0...5 V, max. 5 mA
Parallel connection of several thermostats for one switch	Max. 20 thermostats per switch. Do not mix with D1!
Insulation against mains	N/A, mains potential 

D1-GND

Operating action	Selectable (NO/NC)
Contact sensing	SELV DC 6...15 V, 3...6 mA
Parallel connection of several thermostats for one switch	Max. 20 thermostats per switch.
Insulation against mains	Do not mix with X1/X2! 3.75 kV, reinforced insulation

Function of inputs

External temperature sensor, heating/cooling changeover sensor, operating mode switchover	Selectable X1: P38 X2: P40
contact, dewpoint monitor contact, enable electric heater contact, fault contact, monitoring input	D1: P42

RDG16..KN

 Power supply

Rated voltage	AC 24 V
DC 24 V: Make sure to connect G to + and G0 to -	DC 24 V
Frequency	50/60 Hz
Power consumption	Max. 2 VA/2 W



No internal fuse!

External preliminary protection with max. C 10 A circuit breaker required in all cases.

Outputs

Q1/Q2/Q3/L-N (relay)	AC 24...230 V
----------------------	---------------

Use for 3-speed fan control

Rating min, max resistive (inductive)	5 mA...5(4) A
---------------------------------------	---------------

 Note!

Do NOT connect fans in parallel!

Connect one fan directly, for additional fans, one relay for each speed.

Use for actuator control (Q1, Q2)

Q1 - rating min, max resistive/inductive	5 mA...1 A
--	------------

Q2 - rating min, max resistive/inductive	5 mA...5(4) A
--	---------------

Max total load current Q1+Q2+Q3	.5 A
---------------------------------	------

Use for external equipment (Q1, Q2, Q3)

Rating min, max resistive/inductive Qx	5 mA...1 A
--	------------

Max total load current Q1+Q2+Q3	2 A
---------------------------------	-----



No internal fuse!

External preliminary protection with max. C 10 A circuit breaker in the supply line required under all circumstances

ECM fan control	Y50-G0	SELV DC 0...10 V, Max. ±5 mA
-----------------	--------	---------------------------------

Actuator control	Y10-G0/Y20-G0 (G)	SELV DC 0...10 V, Max. ±1 mA
------------------	-------------------	---------------------------------

Inputs

Multifunctional inputs	SELV
------------------------	------

X1-M/X2-M

Temperature sensor input

Type

QAH11.1 (NTC)

Temperature range

0...49 °C

Cable length

Max. 80 m

Digital input

Operating action

Selectable (NO/NC)

Contact sensing

DC 0...5 V, max. 5 mA

Parallel connection of several thermostats for one switch

Max. 20 thermostats per switch

D1-GND

Operating action

Selectable (NO/NC)

Contact sensing

DC 6...15 V, 3...6 mA

Parallel connection of several thermostats for one switch

Max. 20 thermostats per switch.

Function of inputs

Selectable

External room temperature sensor, heating/cooling

X1: P38

changeover sensor, operating mode switchover

X2: P40



contact, dewpoint monitor contact, enable electric

D1: P42

heater contact, fault contact, monitoring input,

supply air temperature

RDG100KN, RDG16..KN

KNX bus	Interface type	KNX, TP1-64 (electrically isolated)		
	Bus current	20 mA		
Operational data	Bus topology: See KNX manual ("Reference documentation" on page 18)			
	Switching differential, adjustable			
	Heating mode	(P30)	2 K (0.5...6 K)	
	Cooling mode	(P31)	1 K (0.5...6 K)	
	Setpoint setting and setpoint range			
	 Comfort mode	(P08)	21 °C (5...40 °C)	
	 Economy mode	(P11-P12)	15 °C/30 °C (OFF, 5..40 °C)	
	 Protection mode	(P65-P66)	8 °C/OFF (OFF, 5..40 °C)	
	Multifunctional inputs X1/X2/D1			
	Input X1 default value	(P38)	1 (ext. temperature sensor, room or return air)	
	Input X2 default value	(P40)	0 (no function)	
	Input D1 default value	(P42)	3 (Operating mode switchover)	
	Built-in room temperature sensor			
	Measuring range		0...49 °C	
	Accuracy at 25 °C		< ± 0.5 K	
Temperature calibration range		± 3.0 K		
Built-in humidity sensor (RDG165KN)				
Measuring range		10...90 %		
Accuracy (after calibration via P23)		< 5%		
Humidity calibration range		± 10%		
Settings and display resolution				
Setpoints		0.5 °C		
Current temperature value displayed		0.5 °C		
Environmental conditions	Operation			
	Climatic conditions		IEC 60721-3-3	
	Temperature		Class 3K5	
	Humidity		0...50 °C	
	Transport		IEC 60721-3-2	
	Climatic conditions		Class 2K3	
	Temperature		-25...65 °C	
	Humidity		<95% r.h.	
	Storage		IEC 60721-3-1	
	Climatic conditions		Class 1K3	
	Temperature		-25...65 °C	
	Humidity		<95% r.h.	
	Standards and directives	EU conformity (CE)		CE1T3191xx ^{*)} (RDG100KN) CE1T3191xx01 ^{*)} (RDG16..KN)
		Electronic control type		2.B (micro-disconnection on operation)
		RCM conformity		CE1T3191en_C1 ^{*)}
Safety class		II as per EN60730		
Pollution class		Normal		
Environmental Compatibility	Degree of protection of housing		IP30 as per EN60529	

Eco design and labelling directives

The product environmental declaration CE1E3181^{*)} and CE1E3191^{*)} contains data on environmentally compatible product design and assessments (RoHS compliance, materials composition, packaging, environmental benefit, disposal). Based on EU Regulation 813/2013 (Eco design directive) and 811/2013 (Labelling directive) concerning space heaters, combination heaters, the following classes apply:

RDG100KN			
- Application with On/Off operation of a heater	Class I		value 1%
- PWM (TPI) room thermostat, for use with On/Off output heaters	Class IV		value 2%
RDG16..KN			
- Application with On/Off operation of a heater	Class I		value 1%
- Modulating room thermostat, for use with modulating heaters	Class V		value 3%



Meets the requirements for eu.bac certification

See product list at: <http://www.eubacert.eu/licences-by-criteria.asp>

RDG160KN (license 213356)	Energy Efficiency Label	Control accuracy [K]
Fancoil unit systems (2 pipes, 2 wires) (motorized actuator DC, variable fan speed)	AA	Heating 0.1 Cooling 0.1
Fancoil unit systems (4 pipes) (thermal actuator, On/Off, variable fan speed)	A	Heating 0.4 Cooling 0.4

General

Connection terminals Solid wires or stranded wires with wire end sleeves
1 x 0.4...2.5 mm²
or 2 x 0.4...1.5 mm²

Caution

Minimal wiring cross section on L, N, Q1, Q2, Q3, Y1, Y2, Y3, Y4

Min. 1.5 mm²

Housing front color RAL 9003 white

Weight without/with packaging	RDG100KN	0.270 kg/0.380 kg
	RDG16..KN	0.240 kg/0.320 kg

^{*)} The documents can be downloaded from <http://siemens.com/bt/download>.

Reference documentation

Handbook for Home and Building Control - Basic Principles
(<http://www.knx.org/knx-en/training/books-documentation/knx-association-books/index.php>)

Synco	CE1P3127 Communication via the KNX bus for Synco 700, 900 and RXB/RXL Basic documentation
Desigo	CM1Y9775 Desigo RXB integration – S-mode CM1Y9776 Desigo RXB/RXL integration – individual addressing CM1Y9777 Third-party integration CM1Y9778 Synco integration CM1Y9779 Working with ETS

Connection terminals

RDG100KN

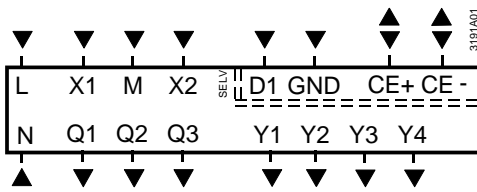

L, N Operating voltage AC 230 V (RDG100KN)
 G, G0 Operating voltage AC 24 V (RDG16..KN)
 L Feed for relays AC 24...230 V (RDG16..KN)
 X1, X2 Multifunctional input for temperature sensor (e.g. QAH11.1) or potential-free switch
 Factory setting:
 – X1 = external temperature sensor
 – X2 = no function
 (function can be selected via parameters P38/P40).

RDG16..KN

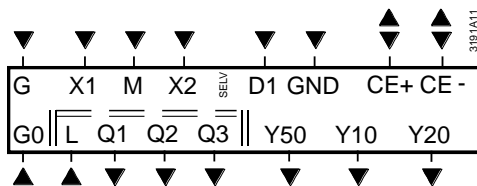

M Measuring neutral for sensors and switches
 D1, GND Multifunctional input for potential-free switch
 Factory setting: Operating mode switchover contact (function can be selected via parameter P42).
 Q1 Control output fan speed I AC 230 V
 Q2 Control output fan speed II AC 230 V
 Q3 Control output fan speed III AC 230 V
 Q1...Q3 Also for special functions AC 24...230 V (RDG16..KN)
 Y1...Y4 Control outputs "Valve" AC 230 V (RDG100KN) (N/O triac, for normally closed valves), output for electric heater via external relay
 Y10, Y20 Control outputs "Valve" DC 0...10 V (RDG16..KN)
 Y50 Control output "Fan" DC 0...10 V (RDG16..KN)
 CE+ KNX data +
 CE- KNX data –

Connection diagrams RDG100KN

Application

V1

V2



- 2-pipe

YHC

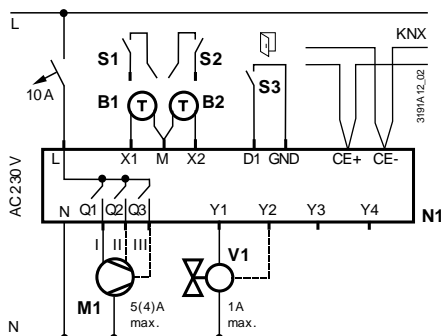

- 2-pipe and radiator
- 4-pipe
- 2-stage

YHC

YR

YH

YC

YHC1

YHC2

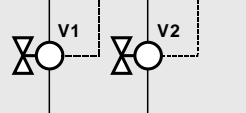

- 2-pipe and electric heater

YHC

YE

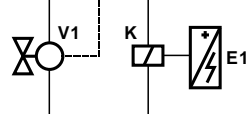

- 4-pipe and electric heater

YH

YC

YE

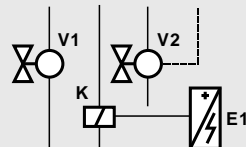

- N1 Room thermostat RDG100KN
- S1, S2 Switch (keycard, window contact, presence detector, etc.)
- S3 Switch at SELV input (keycard, window contact)
- B1, B2 Temperature sensor (return air temperature, external room temperature, changeover sensor, etc.)
- CE+ KNX data +
- CE- KNX data -
- YHC1/YHC2 1st/2nd stage

- M1 1-speed or 3-speed fan
- V1, V2 Valve actuators: On/Off or PWM, 3-position, heating, cooling, radiator, heating/cooling, 1st or 2nd stage
- YE Electric heater
- K Relay
- YH Heating valve actuator
- YC Cooling valve actuator
- YHC Heating/cooling valve actuator
- YR Radiator valve actuator

Connection diagrams RDG16..KN

	DC 0...10 V fan		1-speed/3-speed fan	
Application	V1 ↓	V2 ↓		
• 2-pipe	YHC			
• 2-pipe and radiator	YHC	YR	Q1 Q2	Y10 Y20
• 4-pipe	YH	YC		
• 2-stage	YHC1	YHC2		
Control outputs:	2 x DC		V1 V2	
	1 x DC 1 x On/Off		V1	
	2 x On/Off		V1 V2	
• 2-pipe and electric heater	YHC	YE	Q1 Q2	Y10 Y20
Control outputs:	2 x DC		V1 V2	
	1 x DC 1 x On/Off		V1	
	2 x On/Off		V1 V2	
• Compressor 1-stage	C1		Q1 Q2	Y10 Y20
• Compressor 2-stage	C1	C2		

- | | | | |
|---------|---|-----------|---|
| N1 | Room thermostat RDG16..KN | YE | Electric heater |
| S1...S3 | Switch (keycard, window contact, presence detector, etc.) | M1 | 1-speed or 3-speed fan, DC 0...10 V fan |
| B1, B2 | Temperature sensor (return air temperature, external room temperature, changeover sensor, etc.) | V1, V2 | Valve actuators: On/Off or DC 0...10 V, heating, cooling, radiator, heating/cooling, 1 st or 2 nd stage |
| CE+ | KNX data + | YH | Heating valve actuator |
| CE- | KNX data - | YC | Cooling valve actuator |
| DH | De-Humidifier RDG165KN only | YHC | Heating/cooling valve actuator |
| | Q3=On/Off, Y50=0...10V, See P3191. | YR | Radiator valve actuator |
| | | YHC1/YHC2 | 1 st /2 nd stage |
| | | C1/C2 | Compressor 1 st /2 nd stage |

6-port ball valve

Application
(RDG160KN
only)

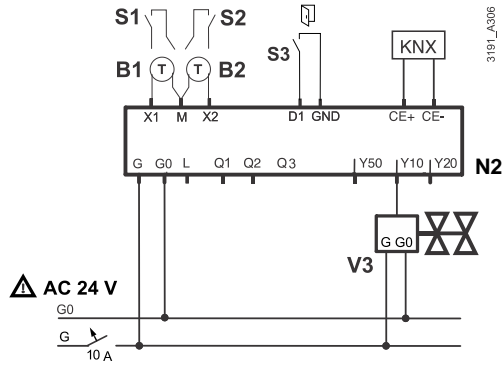

3191_A306

PICV with 6-port ball valve as change over

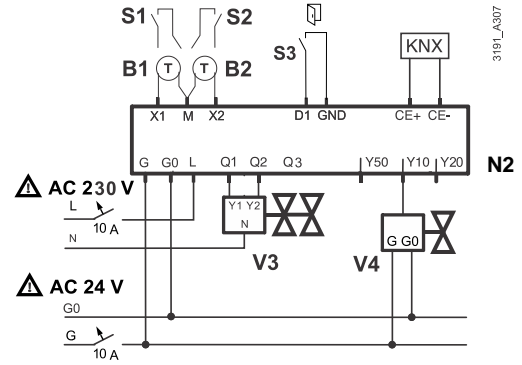

3191_A307

N2	Room thermostat RDG160KN	V3	6-way modulating control actuator (as DC output)
S1...S3	Switch (keycard, window contact, presence detector, etc.)	V4	6-way 3-position control actuator (as H/C changeover control)
B1, B2	Temperature sensor (return air temperature, external room temperature, changeover sensor, etc.)	CE+	KNX data +
		CE-	KNX data -

Dimensions

Dimensions in mm

